

ethanol fireplaces



 vauni



Vauni Scandinavian ethanol fireplaces

Fire has been an important part of Scandinavian culture for thousands of years. In the northern climate its heat and light have been absolutely essential. Just as the hearth in olden times spread warmth and was a natural gathering-place, a flueless open fireplace from Vauni contributes the same features to the modern home.

With flueless fireplaces, Vauni takes the fireplace into a new era. Our ambition is to unite tradition with contemporary needs. We strive for attention to the genuine and original, at the same time as we bring in up-to-date, energy-efficient technology.

The products are developed with a focus on design, precise work and quality. In short, this means beautiful and robust flueless fireplaces that give the user joy and lasting value for many years. ■

>> the fire in focus <<

our design philisophy

Designing a fireplace that paraphrases the profound tradition of wood-burning represents a great challenge. For in this process the fundamental nature of what fire brings about – warmth, harmony, joy – must never be overlooked.

Vauni's design philosophy emanates from the user's emotional need for fire. Much care is devoted to making the products flexible and attractive for people with varying requirements, tastes and living situations. We design unique products that communicate with the user. All materials are carefully selected to harmonize with the value of fire and to express aesthetics, quality and warmth. Consequently, the fireplaces are beautiful, both with and without a fire burning. ■

Markus Grip
Markus Grip, MFA
Vauni

>> fireplaces that are
beautiful both with and
without a fire burning <<



Markus Grip, MFA
Head of Design Vauni

The same enjoyment & warmth but without any soot or ash

Vauni fireplaces are powered by pure bioethanol. Unlike traditional fireplace constructions, no chimney is needed because the residue products of combustion are the same as in ordinary exhaled air – heat, water vapour and carbon dioxide. Vauni's flueless fireplaces are easy to use and require only minimal installation, thus providing superior functionality.

A flueless Vauni fireplace gives the same pleasant warmth and light as a wood-fired open hearth, but without any trouble, soot or ash. ■

Safety & quality

As the owner of a Vauni product, you can be sure of the highest possible technical quality. Our products are designed with a focus on safety and are certified according to European norms. They are powered by the market's most advanced and reliable ethanol burners, developed for optimal properties of operation. All materials are fire-resistant and carefully selected to harmonize with the value of fire and to express aesthetics, quality and warmth.

All Vauni products are manufactured in Sweden which guarantees high product quality as well as ethical working conditions. ■

Vauni fireplaces utilize modern firing technology. The supplied energy goes straight into the room as heat, instead of being lost through the chimney. Thus the efficiency is high and the user does not expend more energy than necessary. Denatured ethanol is biodegradable and a renewable energy source.



Eco-friendly fires



Vauni's products are certified in accordance with the highest European standard by Swedcert – a certification agency accredited by Swedac (Swedish Board for Accreditation and Conformity Assessment), Sweden's national accreditation agency.

Model Overview

Vauni's models are divided in three groups.

Free-standing fireplaces are placed freely on the floor and are fully mobile. ■

Wall-mounted fireplaces that can easily be mounted on most rigid walls, thanks to low temperatures on the rear side. ■

Burner inserts can be built in so as to create almost unlimited design possibilities. ■





vauni globe

Vauni Globe is a flueless fireplace that combines tradition with classic form in a modern interpretation. The model is free-standing with a foot that can be rotated 360 degrees for optimum viewing angle and flexibility. Globe is equipped with the market's most advanced ethanol burner, which burns without smoke, soot or ash. It gives a lovely warmth and the flame's size can be adjusted continuously. The insert around the ethanol burner is available in two exclusive versions: cast iron with a matt finish, and superbly polished black granite. This mobile fireplace is designed to invite togetherness and inspiration. Its design is beautiful to the eye, both with and without a fire burning. ■



Globe White, Granite and High Foot (optional)



Globe Black, Cast Iron



Globe Black, Granite



Globe White, Granite



Insert of polished black granite. Gives Globe a more exclusive appearance and more effective diffusion of light to the ambience from the fire.

	Sphere	Liner	Low foot	High foot
Globe Black, Cast Iron	black	cast iron	included	optional
Globe Black, Granite	black	black granite	included	optional
Globe White, Granite	white	black granite	included	optional

TECHNICAL INFORMATION

Dimensions	600x610x580 mm (w x h x d) 600x900x580 mm (w x h x d) high foot
Weight	38 kg
Heat output	2 kW (max)
Heating capacity	more than 20 m ²
Fuel volume	2 l
Burning time	min 5 h

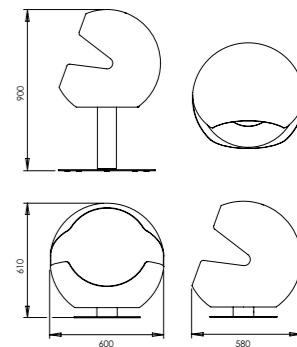

vauni divider

The Vauni Divider has a clean shape to give the fire's vitality maximum space and to inspire free placement in the room. As its name indicates, it is an ideal room-divider combining the transparency of hardened glass with the floating, unique body, which allows the fire to be viewed from all angles. In this way it becomes a superb mood-creator for everyday life as well as parties. The Divider is powered by a newly developed wide-flame bio-ethanol burner with impressive light intensity. Heating effect and flame size are adjusted by using the accompanying design tool. Divider is entirely mobile in order to suit varying needs and spontaneous rearrangements of furniture. Never before has it been more fun and simple to experiment with the interior! ■





Divider Black



Divider Black



Divider Granite

	Mantle colour	Top
Divider Black	black	stainless
Divider Granite	stainless	black granite

TECHNICAL INFORMATION

Dimensions	950x750x395 mm (w x h x d)
Weight	60-70 kg
Heat output	3 kW
Heating capacity	more than 20 m ²
Fuel volume	3 l
Burning time	min 5 h

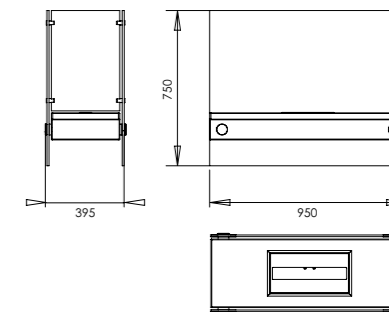

vauni edge

Vauni Edge is a wall-mounted bioethanol fireplace, characterized by timeless Scandinavian simplicity. Its pure, elementary lines suit most interiors, and the flames give a nice heat contribution as well as providing decoration and a lively atmosphere of illumination. The fireplace can be placed on most types of rigid walls, thanks to its low back-side temperature and simple installation. ■

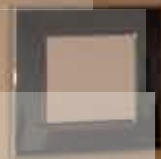

Due to its super-flat construction, Edge looks built into the wall. Vauni Edge comes in three exclusive variants: with front in matt black or white finish, or in brushed stainless steel.

Like all Vauni's products, Edge is more than a chimney-free fireplace – it beautifies its place, whether or not the fire is lit. ■





Edge Stainless



Edge Black



Edge Stainless



Edge White

	Rear casing	Front
Edge Black	black	black
Edge Stainless	black	stainless
Edge White	black	white

TECHNICAL INFORMATION

Dimensions	950x550x160 mm (w x h x d)
Weight	25 kg
Heat output	2 kW
Heating capacity	more than 20 m ²
Fuel volume	2 l
Burning time	min 5 h

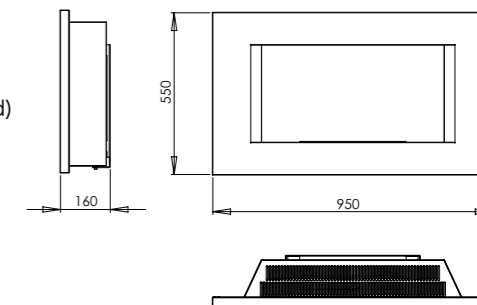

vauni shadow

Vauni Shadow is a wall-mounted bioethanol fireplace with a glass front. Due to its super-flat construction, Shadow looks built into the wall. The unique front of safety glass is both elegant and practical, since it gives protection and can also be opened for easy access to the burner.

The fireplace can be placed on most types of rigid walls, thanks to its low back-side temperature and simple installation. Like all Vauni's products, Shadow is more than a chimney-free fireplace – it beautifies its place, whether or not the fire is lit.



Opening glass front with hidden lock



Shadow

Shadow **Rear casing** **Front**
 Shadow black safety glass & stainless

TECHNICAL INFORMATION

Dimensions 950x550x170 mm (w x h x d)
Weight 30 kg
Heat output 2 kW
Heating capacity more than 20 m²
Fuel volume 2 l
Burning time min 5 h

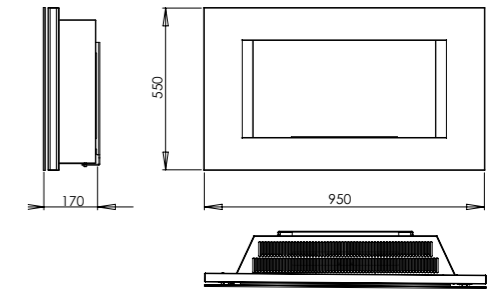



vauni cupola

Vauni Cupola is a wall-mounted chimney-free fireplace that clearly carries the Vauni identity. Its design is characterized by classic form in a modern version giving expression to traditional values. Perhaps the most characteristic feature is the unique profile which, combined with the lightweight aluminum body in black or white matt finish, makes an impressive yet slender wall-ornament. Cupola is as easily installed as a flat-screen TV. Hence, the possibilities of decorating with fire are endless. As with all Vauni fireplaces, the Cupola is equipped with an advanced, adjustable bioethanol burner that allows for vent-less, hassle-free firing. All in all, the Vauni Cupola is more than just a fireplace – it's like a sculpture even when unlit. ■





Cupola Black



Cupola Black



Cupola White

	Rear casing	Hemisphere
Cupola Black	black	black
Cupola White	black	white

TECHNICAL INFORMATION

- Dimensions** 810x350 mm (Ø x d)
- Weight** 27 kg
- Heat output** 2 kW (max)
- Heating capacity** more than 20 m²
- Fuel volume** 2 l
- Burning time** min 5 h

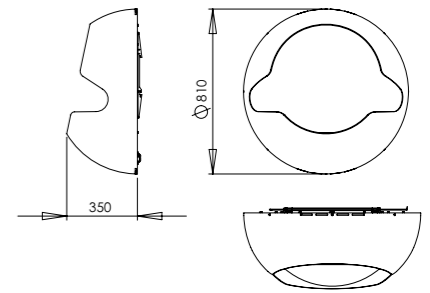

vauni insert burners

For those who want to design their own built-in open fireplace, the bioethanol-powered insert burners CI & CI Wide are the right choice. These products are intended for building into non-flammable material and need no chimney, thereby creating maximum design freedom. The safe flueless technology, combined with the simple installation, makes the possibilities for design almost boundless – imagination alone sets the limits. ■

>> design your own
built-in open fireplace <<







Vauni CI Wide Burner, Brasserie/Winebar Ett, Sweden

Unlimited design possibilities

Vauni CI & CI Wide are bioethanol burners for those who want to design their own built-in open fireplace, but who are unable, unwilling or not allowed to install a chimney in their building. Expensive and complicated chimney installations are thereby consigned to the past. These burners are easy to use and install – just inserted into fireproof* material. The version CI Wide has a broader flame and gives more heat. ■



CI



CI Wide



bathroom



room divider



kitchen

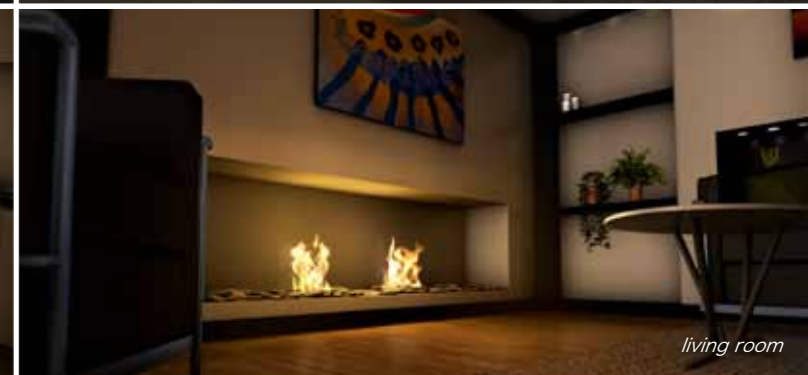

living room

Installation principles

Vauni CI requires only minimal installation work. In spite of that, the following safety aspects must be followed:



1

Choose only nonflammable materials.

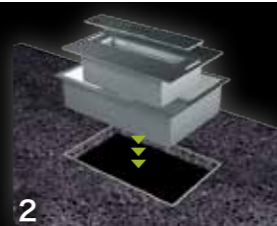

2

Let a professional or a person with good technical knowledge do the work.

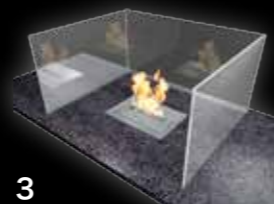

3

Have a fire expert, such as a chimney-sweep, approve the installation before it is put in use.



bedroom



patio/terrace

* Examples of fireproof materials: stainless steel, minerite, bricks, tiles, cement, safety glass & stone

For those who have an open fireplace but want to avoid wood, soot and ash

Vauni OF Wide is a bioethanol burner that can easily be placed in an existing open fireplace. It suits people who are tired of dirt, soot and ash that come from burning wood. If necessary, and without installation, an existing open fireplace can be converted to bioethanol operation. The new technology's advantages are thus gained in a comfortable way. ■



OF Wide

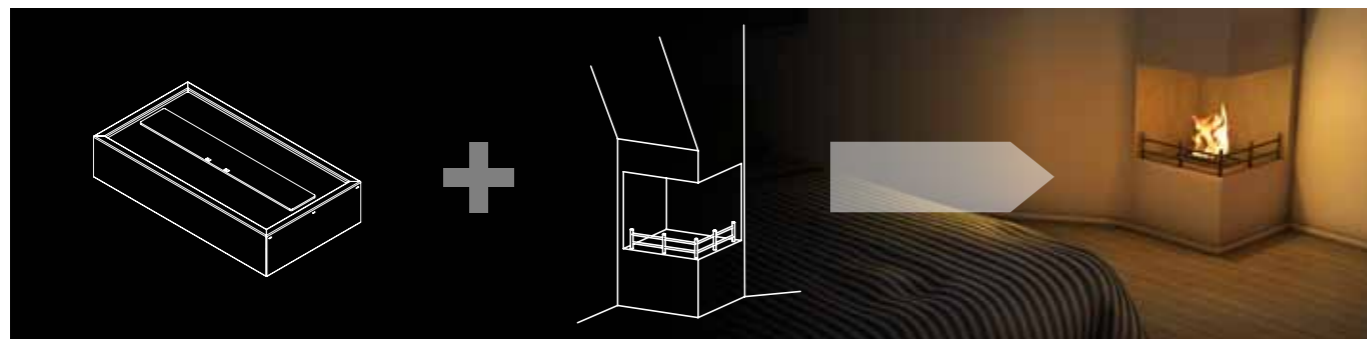

economy

When it comes to economics, we are confident that a flueless product from Vauni is among the most cost-effective fireplace solutions on the market. The greatest saving is that no expensive chimney installation is needed. Thanks to energy-efficient technology, the operating cost is also advantageous in comparison to firing with gas or bought wood. ■

Total cost comparison*

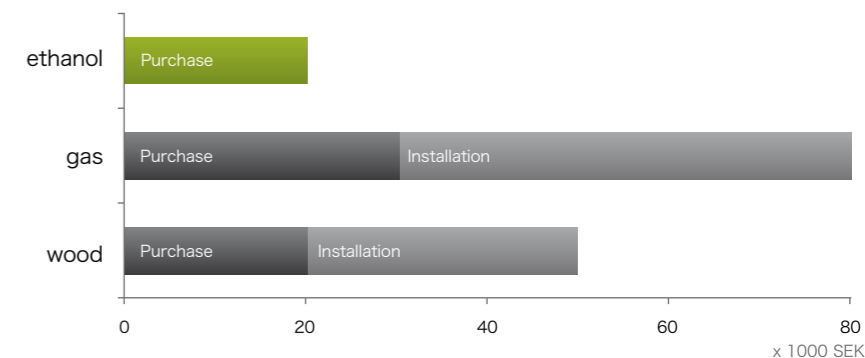

Operating cost comparison*

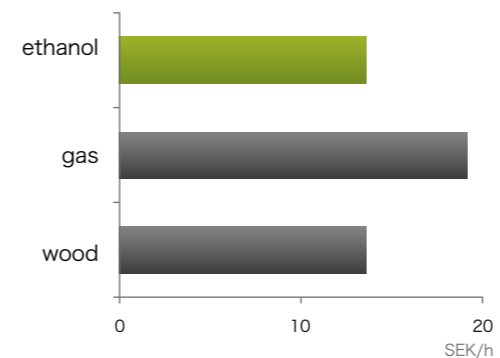

- Total cost (purchase + installation) lowest for ethanol, followed by wood and gas
- Operating cost similar for wood and ethanol, highest for gas
- Maintenance costs are additional for wood and gas

Source: Vauni

* Cost calculations are based on several assumptions, see www.vauni.com

technical information

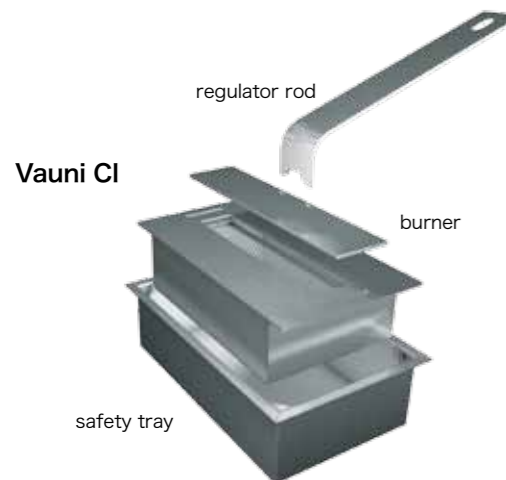

User-friendliness is one of the main benefits of the flueless technology. The handling of a Vauni burner can be described in three steps.

Three simple steps

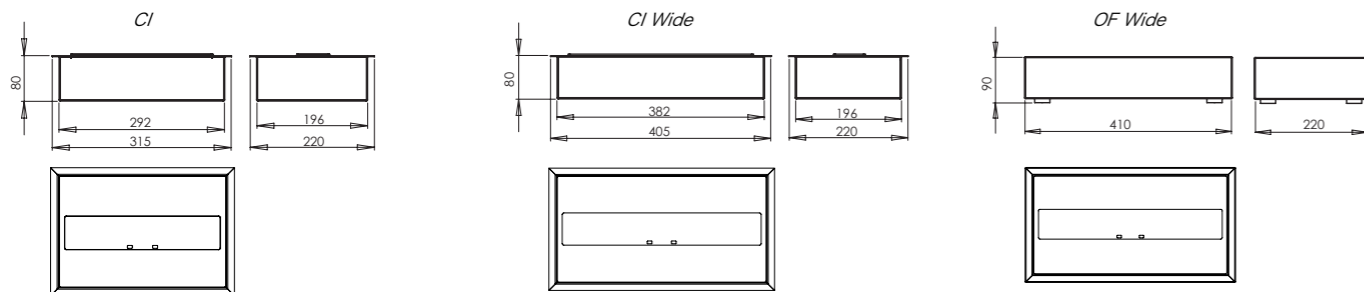
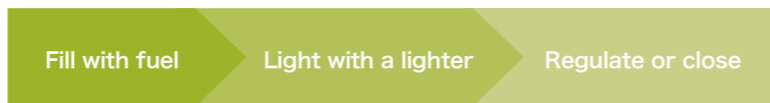

Installation and safety distance (mm)

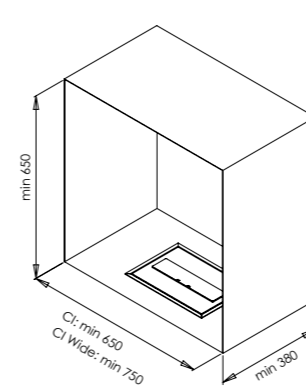

With fire box (insert)
One burner

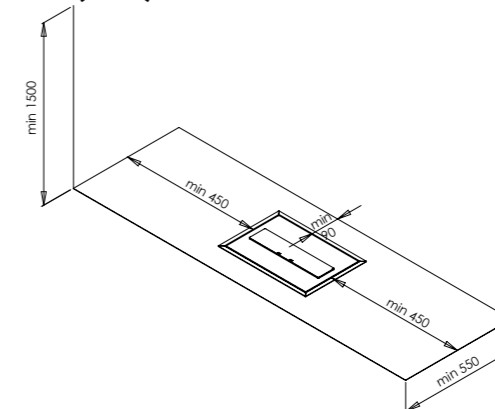

Without fire box (insert)
One burner

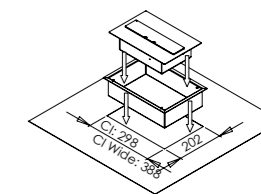

Assembly hole

TECHNICAL INFORMATION

	CI	CI Wide	OF Wide
Dimensions (w x h x d)	315x80x220 mm	405x80x220 mm	410x90x220 mm
Assembly hole (w x d)	298x202 mm	388x202 mm	-
Weight	4 kg	5,5 kg	5,5 kg
Heat output	2 kW	3 kW	3 kW
Fuel volume	2 l	3 l	3 l
Burning time	min 5 h	min 5 h	min 5 h

Distance between burners

For two or more burners, with or without insert – note additional installation width.

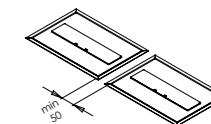



Your contact



www.vauni.com | contact@vauni.com
for online store or nearest showroom

© Vauni AB 2012. All copyright and design rights reserved. Vauni is a registered trademark.



Certified according to the
highest European standards